

RCP-M7 Series Horizontal High speed Centrifugal Pump

- Capacity:800gallon/min.(410mtr/hour)
- Head:14500feet(4420meters)
- Sunction pressure:1000psi(70pasteur)
- Temp. scope: -200 to 500°F(-130 to 260°C)

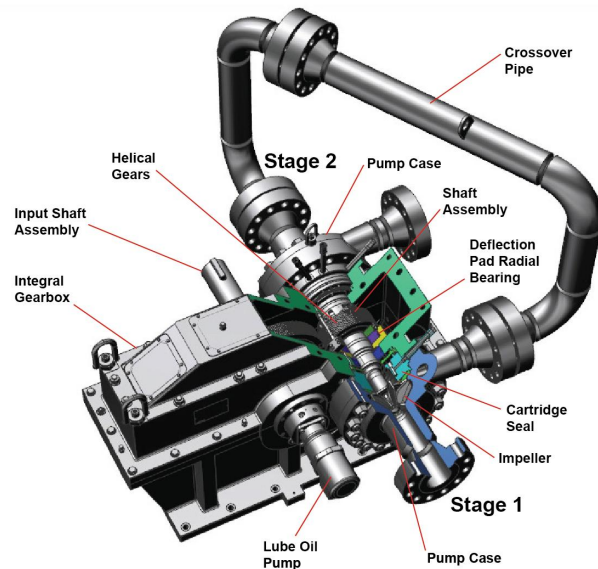

RCP-M3/M5/M7 Horizontal High speed Centrifugal Pump Parameter

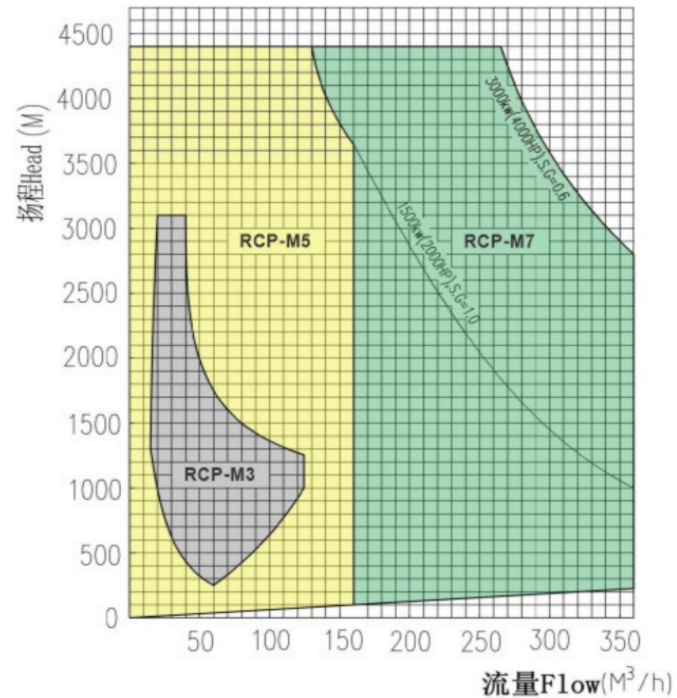

Model	RCP-M3	RCP-M5	RCP-M7
Max.Capacity (m³/h)	110	150	410
Max.Head (m)	3050	4420	4420
Max.Sunction Pressure(MPa)	10.0	10.0	10.0
Max.Operating Pressure(MPa)	30.0	45.0	45.0
Max. Motor Power(kW)	630	1850	3000
Operating Temp. (°C)	-130-+340	-130-+340	-130-+340
Rotate Speed (rpm)	5212-19200	5500-22000	5500-22000
Gearbox Structural Form	Level 1 speedup	Level 1 speedup	Level 1 speedup

Partial Parts Display





Zhejiang Ruichen Pump Technology Co.,Ltd

OFFICE Address: Rm.203-5, Building 30, Hangzhou Bay New Economic Park, Jiaxing Port District, Jiaxing City, Zhejiang Province, China.

FACTROY Address: Bulding No.5, Binhai Pioneer Park, Jiaxing Port District, Jiaxing City, Zhejiang Province,China.

Website: www.hdsrm.com

Tel:86-573-85531362 **Fax:**86-573-85531062

Mobile/Wechat: 86-15105872388

Email: ruichenpump@126.com

